

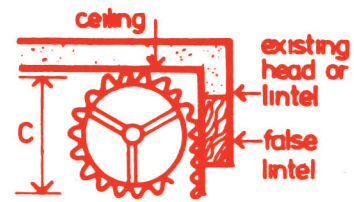

# GLIDEROL® GARAGE DOORS

## HOW THE GLIDEROL ROLLER DOOR IS FITTED IF THERE IS LITTLE OR NO HEAD ROOM



### WITH A FALSE LINTEL

A false head or lintel covered with fibre, timber or masonite can be fitted to your garage as indicated if the existing headroom is less than the requirements shown as dimension "C".

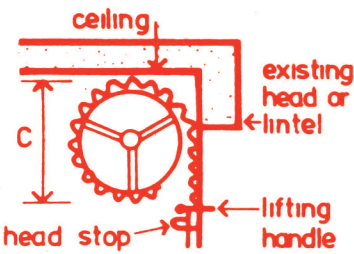

### HEAD STOPS

Head Stops are standard equipment on Series B doors and limit the upward movement of the door. Therefore, positioning of head or lintel is not critical

## HOW TO FIT THE GLIDEROL ROLLER DOOR

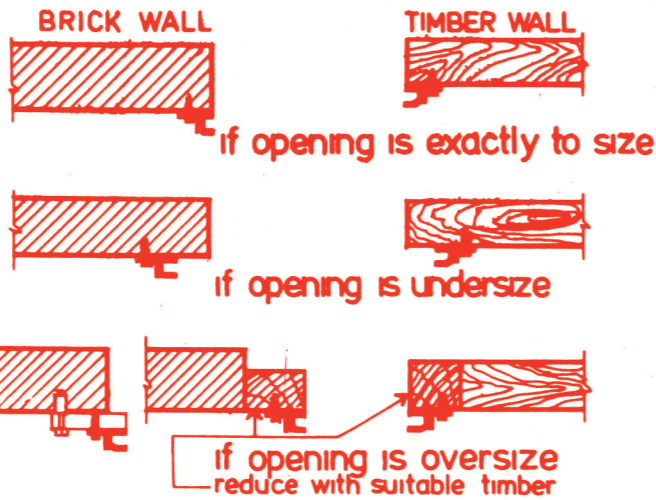

THE ABOVE METHOD APPLIES TO ALL DOOR SIZES

### GUIDE TRACKS

Must be kept clean for a smoother running performance. Do not use grease.

### PAINTING

Although the rustproofed Gliderol Roller Door does not require painting it is recommended that if decorating is desired painting be carried out immediately after installation. Follow paint manufacturers instructions for galvanised steel.

### MAINTENANCE

If correctly installed the Gliderol Roller Door should not require maintenance attention except to clean the guide tracks with a kerosene soaked rag and relubricate if the operation becomes sluggish. Any adjustments to spring tension should be carried out in accordance with the detailed instructions.



# GLIDEROL® GARAGE DOORS

## INSTALLATION REQUIREMENTS

The GLIDEROL DOOR normally operates behind the opening over-laps as shown. Openings should, therefore, have sufficient return on both sides to accommodate support brackets and channel guides with necessary working clearances.

The GLIDEROL ROLLER DOOR is supported on brackets above the opening at each end and requires headroom for the door to roll up. Consequently doorway piers, stiles or posts must continue up past the lintel height to provide fixing for the support brackets.

It is preferable that lintels be built flush with or slightly forward of piers or stiles, if possible. This avoids an excessive gap between door and lintel, while allowing sufficient working clearance to prevent door rubbing against back of lintel.

NOTE: Door curtain overlap - Series B 50mm each side (min.)

DIMENSION PANEL (minimum unless otherwise shown)							
	A1	A2	B	C	D	E	F
<b>SERIES B</b> Hand Operated Up to 8' high	150 mm	125 mm	50-100 mm max	460 mm	460 mm	190 mm	265 mm
Up to 10' high	150	125	50-100 max	480	480	205	280
<b>SERIES B</b> Chain operated Up to 8' high	205	125	50-100 max	460	460	190	265
Up to 10' high	205	125	50-100 max	480	480	205	280
Over 10' high	205	125	50-100 max	530	530	230	305

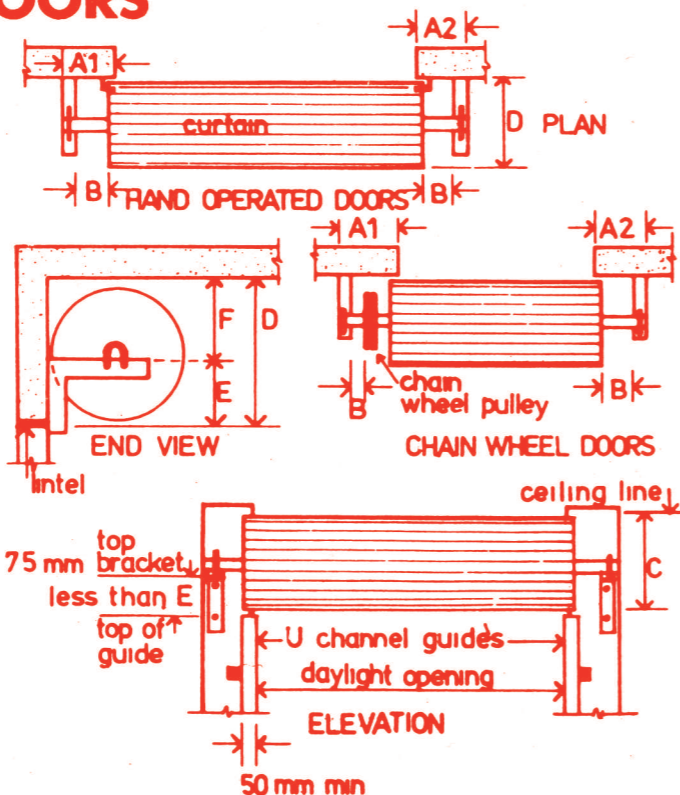

# SPECIFICATION AND INSTALLATION INSTRUCTIONS



# GLIDEROL® GARAGE DOORS

Opening doors around the world

Made under licence Aust Patent No. 413178 and Patent Application No. 483904

## SERIES B INDUSTRIAL DOORS

- Your Gliderol Roller Door is designed to highest engineering standards and manufactured from high quality materials. If it is installed in accordance with instructions given in this folder it will give many years of service with a minimum of maintenance.
- These instructions cover the erection of Industrial Series (hand or chain operated) Roller Doors to suit openings up to a maximum size of 5000mm high x 5000mm wide.
- WARNING: NO GUARANTEE WILL BE GIVEN OR RESPONSIBILITY ACCEPTED BY THE MANUFACTURERS IF THE DOOR IS NOT ERECTED AS INSTRUCTED. FOR PERFECT OPENING ACTION FOLLOW THE INSTRUCTIONS CAREFULLY.**
- NOTE: If, with high or wide doors, difficulty is experienced in obtaining sufficient clearance between the door and the back of the lintel, it is advisable to pack out the guides in preference to moving the door back on the slotted brackets. This method will also assist the operation of the door.
- Heavy Duty Construction, manufactured from steel, roll-formed sheets, lock seamed and pop-rieveted for extra strength, with roller bearings as a standard fitting.
- Security provided with a pad-bolt locking system either inside or outside, or on both sides of door.
- Wicket Gates 1200 mm x 600 mm are available however, it is advisable to check L.G.A. regulations.
- Are available with single or multiple lift out mullions for multiple openings.
- Low Cost compared with shutters, with minimum servicing and maintenance and low purchases and installation cost.
- Ease of Operation with a specially designed and engineered springing system, combined with a chain operation, giving easy smooth operation.
- Gliderol Roller Doors are covered by Gliderol's standard Warranty.
- Sales and Service are available in all Capital Cities in Australia.
- In the interest of continuing technical development we reserve the right to modify designs and equipment.
- This brochure is not to be reproduced wholly or in part without written permission.

## GLIDEROL GARAGE DOORS PTY LTD

32 Jacobsen Crescent Holden Hill SA 5088

Phone (08) 8261 9633 Fax (08) 8261 9700

### BRANCHES

**Victoria:** Gliderol Doors Pty Ltd, 23 Kitchen Road, Dandenong VIC 3175. Phone (03) 9793 5455 Fax (03) 9706 8492

**New South Wales:** Gliderol Manufacturing (NSW) Pty Ltd, 45 Sammut Street, Smithfield NSW 2164. Phone (02) 9725 1033 Fax (02) 9725 1115

**Queensland:** Gliderol Door Manufacturing (QLD) Pty Ltd, 45 Harvey Street, Eagle Farm QLD 4009. Phone (07) 3868 2766 Fax (07) 3868 2760

**Western Australia:** Gliderol Garage Doors Pty Ltd, 21 Prindiville Drive, Wangara WA 6065. Phone (08) 9409 3000 Fax (08) 9409 3200

**Tasmania:** Gliderol Garage Doors Pty Ltd, 23 Lindsay Street, Invermay Tas 7248 Phone (03) 6334 3530 Fax (03) 6334 5273



# PLEASE READ THIS LEAFLET COMPLETELY BEFORE COMMENCING INSTALLATION

# 1

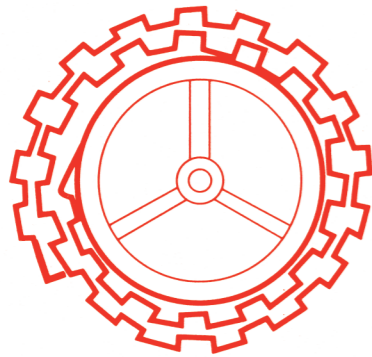

- **DO NOT** cut the bands that hold the door in a roll. These bands are to be cut at step 6 only.
- Gliderol roller doors always overlap the opening on each side.
- Before commencing erection, measure both the opening width, and the door curtain width, and mark the overlap of the curtain on the wall. This will facilitate the fixing of brackets and guides at a later stage.

# 2

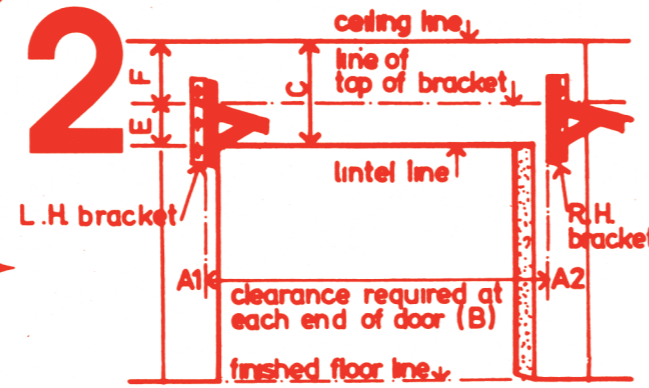

- Determine correct dimensions for position, height and side clearance of brackets as shown on back page, according to door size. (These dimensions are A1, A2, B, E and F).
- Allow clearance (B) on chain wheel side for chain pulley to rotate without fouling bracket. (Check the measurements of the door while it is still on the ground).
- If normal head room (C) is not available, fix bracket height from ceiling as per (F).
- Secure support brackets with coach bolts or screws to timber, or with Loxins or similar masonry fixing if to brick. (**DO NOT** use plastic or wooden plugs).
- Both brackets must be level, otherwise the door will roll up unevenly, use a straight edge.

# 3

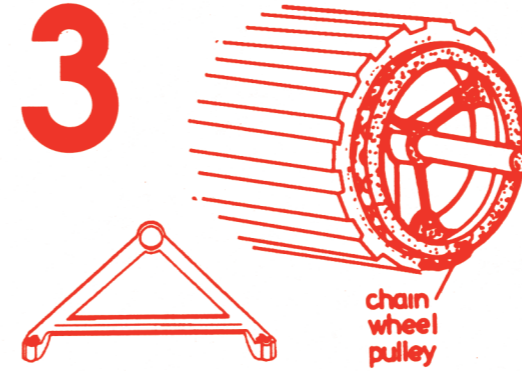

**DIRECT DRIVE CHAIN WHEEL DOORS**

- FOR DIRECT DRIVE CHAIN OR HAND OPERATED DOORS
- With door on ground, firmly grasp axle with both hands and rotate as far as possible, then release grip suddenly so that the axle revolves backwards. This will centralise the axle in relation to the door curtain.
- Fit chain guide as shown.
- Lift rolled up door onto brackets and loosely secure with 'U' bolts, washers, nuts and saddles to prevent falling.
- Position the axle to allow the door to revolve without scraping the back of the lintel.
- Centralise door opening and make sure that if sideways movement is necessary, both axle and curtain be moved together, otherwise the axle will be pushed out of centre to the curtain, causing the door to roll up unevenly.

# 4

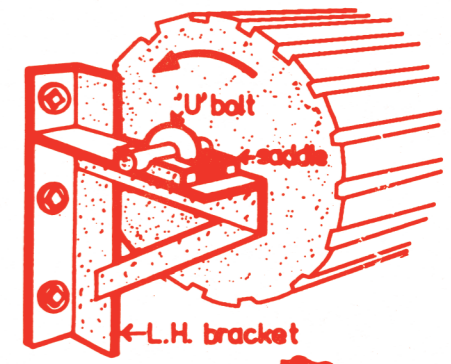

**IMPORTANT** fit keeper plate to top of double saddle

**DOUBLE SADDLE** alternative methods of axle clamping for doors over 3M high

- FOR DOUBLE SADDLE
- Secure axle on saddles set on brackets of both ends with 'U' bolts which must be locked very tightly using washers under nuts.
- Spring tension will be lost if axle is not clamped tightly.
- FIT CHAIN TO CHAINWHEEL.
- Join chain ends together firmly (the chain must not be twisted).
- Fit chain clip to the wall allowing clearance for future fixing of guides.

# 8

- Should the door be hard to raise, and tend to drop, then more spring tension is required.
- If door is hard to close and tends to rise then less spring tension is required.
- Alterations to spring adjustment should be made in small amounts only, until the best position is found.

## FIXING BOLT ETC

Coach Screws are the standard fixing items supplied with the Gliderol Roller Door. If masonry fixing is required the use of 3/8" Loxins (or similar) (use 5/8" masonry drill) and 2-1/4" x 3/8" Hexagon Head Bolts is recommended for the brackets. For the guides use No. 20 Fibre Rawl Plugs (3/8" masonry drill) with the 5/16" Coach Screws supplied. Never leave in doubt the fixing of the support Brackets. Use coach bolts with backing plates or large washers through wall in soft masonry, loose brick or soft woods.

# 7

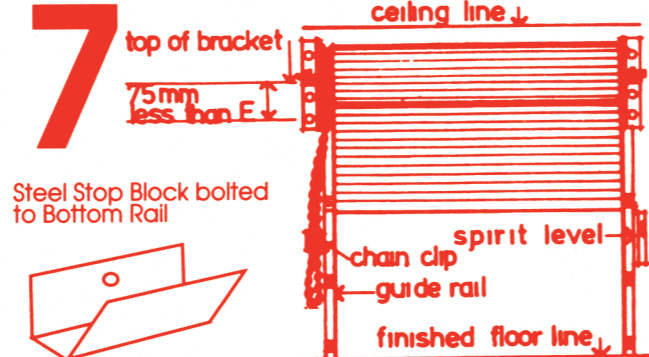

- Ensure that curtain is rolled up evenly and centred on opening.
- Check guides for correct height (i.e. from top of wall brackets to finished floor level less 75mm).
- **NOTE:** Bottom of guides must be at finished floor level. If the floor is not level, always work from the highest side first. The top of the guides (the splayed ends) should be 115mm Min to 150 Max. below the top of the support bracket (if necessary cut guide at bottom).
- Slide both guides onto the door curtain allowing 3mm side clearance.
- Hold the guide in position against the wall and mark location of top fixing (use a spirit level to ensure the guides are vertical).
- Fix guide to wall.
- Fix second guide as above (the top of both guides must be level with each other).
- **NOTE:** For masonry fixing use a 3/8" Loxin or equivalent in both the top and bottom fixing lug of each guide.

# 6

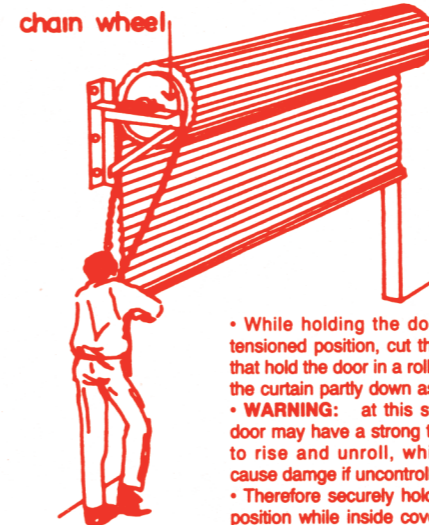

- While holding the door in its tensioned position, cut the bands that hold the door in a roll and pull the curtain partly down as shown.
- **WARNING:** at this stage the door may have a strong tendency to rise and unroll, which may cause damage if uncontrolled.
- Therefore securely hold door in position while inside cover plates and lock bolt assembly are fitted to the bottom rail as shown below (P.K. Screws should be used).

# 5

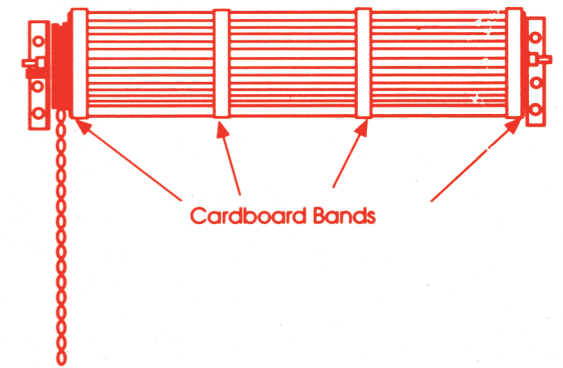

- SPRING TENSIONING**
- Rotate the door one to two full turns in the direction of the arrow (shown in step 4).

## ATTACHING GUIDES

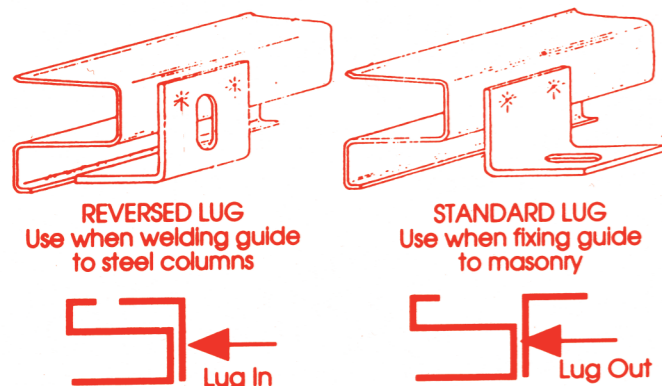

**REVERSED LUG**  
Use when welding guide to steel columns

**STANDARD LUG**  
Use when fixing guide to masonry



## ATTACHING BRACKETS

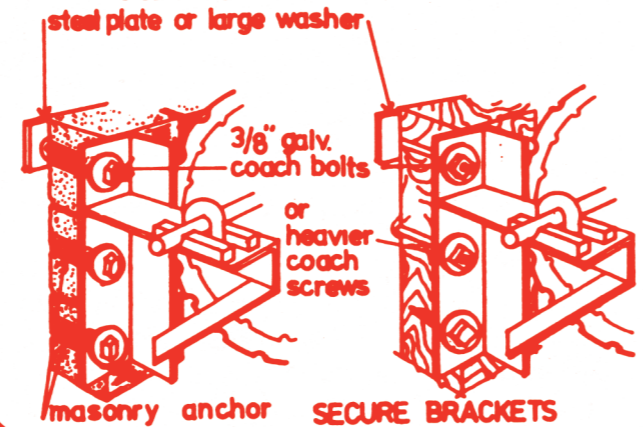

## LOCKING DEVICE

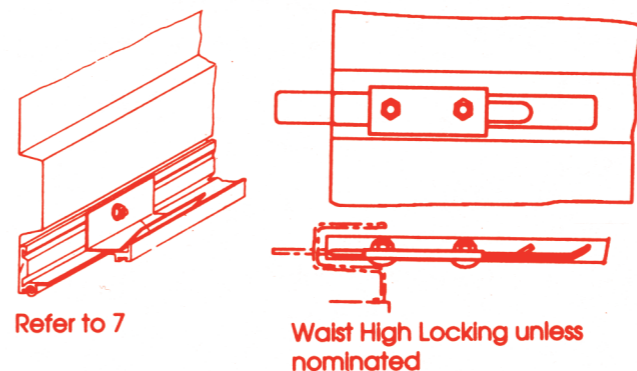

Refer to 7

Waist High Locking unless nominated

## ADJUSTING SPRING TENSION

**WITH DOOR IN OPEN POSITION**

- to loosen spring tension

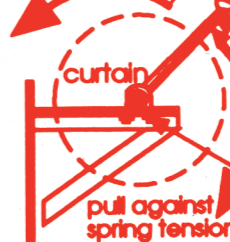

**WARNING - IMPORTANT**  
Axle must be firmly held before loosening 'U' bolts. **DO NOT** attempt to loosen bolts before securing firm hold on with stilsons. (See notes in Step 8 regarding high or wide doors)

- Stilson to be used for spring tension
- Firmly hold axle before loosening U bolts
- U bolts to be loosened at both ends
- To **TIGHTEN** spring tension